

По вопросам продаж и поддержки обращайтесь:

Алматы (7273)495-231  
Ангарск (3955)60-70-56  
Архангельск (8182)63-90-72  
Астрахань (8512)99-46-04  
Барнаул (3852)73-04-60  
Белгород (4722)40-23-64  
Благовещенск (4162)22-76-07  
Брянск (4832)59-03-52  
Владивосток (423)249-28-31  
Владикавказ (8672)28-90-48  
Владимир (4922)49-43-18  
Волгоград (844)278-03-48  
Вологда (8172)26-41-59  
Воронеж (473)204-51-73  
Екатеринбург (343)384-55-89  
Иваново (4932)77-34-06  
Ижевск (3412)26-03-58  
Иркутск (395)279-98-46  
Казань (843)206-01-48

Калининград (4012)72-03-81  
Калуга (4842)92-23-67  
Кемерово (3842)65-04-62  
Киров (8332)68-02-04  
Коломна (4966)23-41-49  
Кострома (4942)77-07-48  
Краснодар (861)203-40-90  
Красноярск (391)204-63-61  
Курган (3522)50-90-47  
Курск (4712)77-13-04  
Липецк (4742)52-20-81  
Магнитогорск (3519)55-03-13  
Москва (495)268-04-70  
Мурманск (8152)59-64-93  
Набережные Челны (8552)20-53-41  
Нижний Новгород (831)429-08-12  
Новокузнецк (3843)20-46-81  
Новосибирск (383)227-86-73  
Ноябрьск (3496)41-32-12

Омск (3812)21-46-40  
Орел (4862)44-53-42  
Оренбург (3532)37-68-04  
Пенза (8412)22-31-16  
Пермь (342)205-81-47  
Петрозаводск (8142)55-98-37  
Псков (8112)59-10-37  
Ростов-на-Дону (863)308-18-15  
Рязань (4912)46-61-64  
Самара (846)206-03-16  
Санкт-Петербург (812)309-46-40  
Саранск (8342)22-96-24  
Саратов (845)249-38-78  
Севастополь (8692)22-31-93  
Симферополь (3652)67-13-56  
Смоленск (4812)29-41-54  
Сочи (862)225-72-31  
Ставрополь (8652)20-65-13  
Сургут (3462)77-98-35

Сыктывкар (8212)25-95-17  
Тамбов (4752)50-40-97  
Тверь (4822)63-31-35  
Тольятти (8482)63-91-07  
Томск (3822)98-41-53  
Тула (4872)33-79-87  
Тюмень (3452)66-21-18  
Улан-Удэ (3012)59-97-51  
Ульяновск (8422)24-23-59  
Уфа (347)229-48-12  
Хабаровск (4212)92-98-04  
Чебоксары (8352)28-53-07  
Челябинск (351)202-03-61  
Череповец (8202)49-02-64  
Чита (3022)38-34-83  
Якутск (4112)23-90-97  
Ярославль (4852)69-52-93

Россия +7(495)268-04-70

Казахстан +7(7172)727-132

Киргизия +996(312)96-26-47

сайт: [www.acvatix.nt-rt.ru](http://www.acvatix.nt-rt.ru) || эл. почта: [atv@nt-rt.ru](mailto:atv@nt-rt.ru)



## ТЕХНИЧЕСКИЕ ХАРАКТЕРИСТИКИ НА ЭЛЕКТРОМОТОРНЫЕ ПРИВОДЫ SQK34.00 SQK84.00



### Electromotoric Actuators

for slipper valves with 90° angle of rotation

- **SQK34.00** operating voltage AC 230 V
- **SQK84.00** operating voltage AC 24 V
- 3-position control signal
- Nominal angle of rotation 90°
- Nominal torque 5 Nm
- For direct assembly with no need of mounting kit
- 1 auxiliary switch for extra functions
- Manual adjuster and position indicator
- Mode of operation «AUTO» or «MAN»
- Reversible electromotoric actuator

#### Use

For use in heating, ventilation and air conditioning systems to operate type VBF21..., VBG31..., VBI31..., VCI31.. 3-port and 4-port slipper valves up to DN 50 (refer to «Equipment combinations»).

**SIEMENS**

## Type summary

Type	Operating voltage	Positioning signal	Positioning time for 90° at 50 Hz	Torque
<b>SQK34.00</b>	AC 230 V	3-position	135 s	5 Nm
<b>SQK84.00</b>	AC 24 V			

## Accessories

Type	Description
<b>ASC9.7</b>	Auxiliary switch



## Order

The actuator and accessories must be ordered separately.

When ordering please specify the quantity, product name and type code.

Example

**1 actuator SQK34.00**  
**1 auxiliary switch ASC9.7**

## Delivery

The actuator and accessories are packed separately and delivered as individual items.

## Spare parts, rev. no.

Overview see page 6.

## Equipment combinations

	Slipper valves	Actuators SQK34.00, SQK84.00	Data sheet
3-port valve	<b>VBF21.., Series 02</b>	DN 40...50	N4241
	<b>VBI31.., Series 02</b>	DN 20...40 (¾...1½")	N4232
	<b>VBG31.., Series 02</b>		N4233
4-port valve	<b>VCI31.., Series 02</b>	DN 20...40 (¾...1½")	N4252

## Function / mechanical design

These electromotoric actuators require no maintenance. They have a reversible synchronous motor.

The actuator is driven by a 3-position signal from the controller and generates a rotary motion which is transferred via a pin in the slipper valve shaft to the 3-port or 4-port slipper valve.

The actuators are supplied with a 90° angle of rotation. During automatic operation, rotation is limited by two built-in end-switches.

The direction of operation of the actuator can be reversed (refer to «Commissioning»).

Direction of rotation of the actuator on delivery:

- Voltage at Y1 = Counter-clockwise rotation (ccw)
- Voltage at Y2 = Clockwise rotation (cw)
- No voltage = No rotation; actuator fixed in relevant position

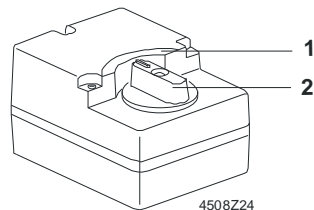

- 1 Position indicator, can be changed manually, depending on the required direction of rotation
- 2 Manual setting knob  
When the selector is set to «MAN», the valve can be operated with a manual knob.



3 Selector for automatic or manual operation

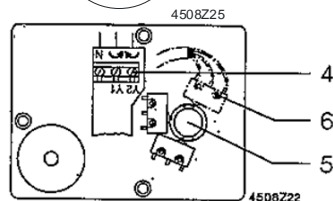

4 Connecting terminals

5 Coupling and cam shaft

6 Space for auxiliary switch

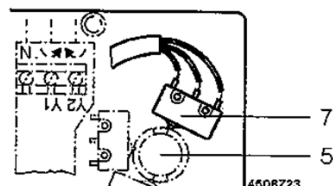

7 Auxiliary switch ASC9.7

For on / off changeover operation. The switching point is adjustable.

Factory-wired with a three-wire cable of 1.5 m.

## Engineering notes

### Electrical installation

The actuators must be electrically connected in accordance with local regulations and with the connection diagrams.



**Regulations and requirements to ensure the safety of people and property must be observed at all times.**

If additional functions are required, the actuator must be equipped with an auxiliary switch. The relevant switching point must be noted in the plant documentation

## Mounting notes

Overview of  
Mounting Instructions

Type	Mounting Instructions
<b>SQK34.00, SQK84.00</b>	M4508 74 319 0448 0

Type	Mounting Instructions
<b>ASC9.7</b>	G4508.1 4 319 5579 0

The valve and actuator can be assembled straightforwardly on site. There is no need for special tools.

### Orientation

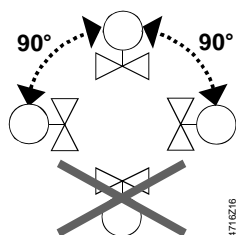

## Commissioning notes

When commissioning the complete motorized valve consisting of actuator and slipper valve, always check the wiring and test the functions. This also applies to the additional auxiliary switch ASC9.7 fitted.

For automatic operation, the selector must be set to «AUTO»

### Mode of operation



«AUTO» = automatic operation



«MAN» = manual operation

## Position indication



Manual setting «**FULLY CLOSED**»  
= no supply of heat \*



Manual setting «**FULLY OPEN**»  
= maximum supply of heat \*

\* If the hydraulic circuit is reverse, the removable scale for the position indication must be turned.

## Direction of rotation

The actuators are factory-set to rotate in counter-clockwise (ccw) direction for opening. The direction of rotation of the actuator or the slipper valve is determined by the

- Boiler flow (from left or right)
- Position of the slipper valve (hydraulic circuit)

## Reversing the direction of rotation

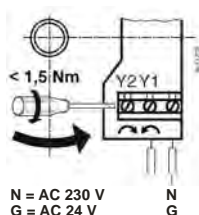

Control signal supplied to terminal **Y1**  
= **counter-clockwise direction** (ccw)

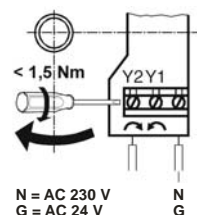

Control signal supplied to terminal **Y2**  
= **clockwise direction** (cw)

The wiring connecting terminals Y1 and Y2 must be inverted if the direction of rotation is reversed. If an auxiliary switch is mounted, it must be taken into consideration when making the electrical connections.

## Setting the angle of rotation

The angle of rotation is factory-set to 90° and cannot be adjusted.

## Control

Every actuator must be driven by a dedicated controller.

## Maintenance

The actuators require no maintenance.

### Caution

Before performing any service work on the slipper valve or actuator:

- Switch off the pump and power supply
  - Close the main shut-off slipper valves in the pipework
  - Release pressure in the pipes and allow them to cool down completely
- If necessary, disconnect electrical connections from terminals.

The slipper valve must be re-commissioned only with the manual adjuster or the actuator correctly assembled.

## Disposal

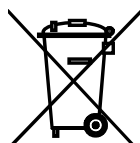

The actuator contains electrical and electronic components and must not be disposed of together with domestic waste.

Legislation may demand special handling of certain components, or it may be sensible from an ecological point of view.

**Current local legislation must be observed.**

## Warranty

The technical data given for these applications is valid only in conjunction with the Siemens butterfly and slipper valves as detailed under «Equipment combinations». The use of third-party slipper valves other than those recommended by Siemens invalidates the warranty.

## Technical data

		SQK34.00	SQK84.00	
Power supply	Operating voltage	AC 230 V, ± 15 %	AC 24 V, ± 20 %	
	Frequency	50 / 60 Hz		
	Power consumption <sup>1)</sup>	3 VA	2 VA	
Control	Positioning signal	3-position		
	Parallel operation	parallel operation of several actuators not possible		
Operating data	Positioning time for 90°	135 s		
	Angle of rotation	90° ± 3° (factory setting)		
	Torque <sup>1)</sup>	10 Nm		
	<b>Starting torque</b>	10 Nm		
	<b>Nominal torque</b>	5 Nm		
Norms and standards	CE-conformity	2004/108/EC		
	EMC-directive	EN 61000-6-2 Industrial <sup>2)</sup>		
		Immunity	EN 61000-6-3 Residential	
		Emission	EN 61000-6-3 Residential	
	Low voltage directive	2006/95/EC		
		Electrical safety	EN 60730-1	
	Product standards for automatic electric controls	EN 60730-2-14		
	Protection standard EN 60730	Class II	Class III	
	Housing protection standard	IP42 to EN 60529		
	Upright to horizontal	IP42 to EN 60529		
Environmental compatibility	ISO 14001 (Environment) ISO 9001 (Quality) SN 36350 (Environmentally compatible products) RL 2002/95/EG (RoHS)			
Dimensions / weight	Dimensions	see «Dimensions»		
	Cable glands	1 x Ø 20.5 mm (for M20)		
	Weight	0.5 kg		
Materials	Housing base, yoke	plastic		
	Cover	plastic		

<sup>1)</sup> These values apply at nominal voltage, at an ambient temperature of 20 °C and at the specified nominal running time

<sup>2)</sup> Transformer 160 VA (e.g. Siemens 4AM 3842-4TN00-0EA0) for AC 24 V actuators

### Accessories for SQK34.00, SQK84.00

Auxiliary switch ASC9.7	Switching capacity	AC 250 V, 10 A resistive, 3 A inductive
-------------------------	--------------------	---

General ambient conditions	Operation	Transport	Storage
	EN 60721-3-3	EN 60721-3-2	EN 60721-3-1
Environmental conditions	Class 3K5	Class 2K3	Class 1K3
Temperature	-15...+50 °C	-30...+65 °C	-30...+65 °C
Humidity	5...95 % r. h.	< 95 % r. h.	0...95 % r. h.

## Internal diagrams

**SQK34.00**

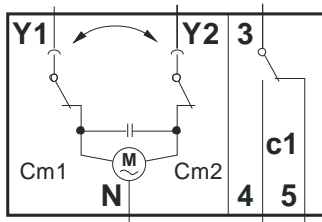

4509G01

**SQK84.00**

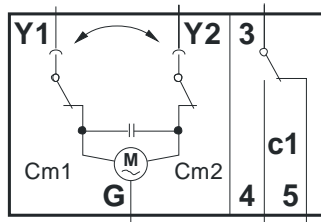

4509G02

- Cm1 End switch
- Cm2 End switch
- c1 1 auxiliary switch **ASC9.7**
- N Neutral conductor
- G System potential
- Y1 Control signal counter-clockwise (ccw)
- Y2 Control signal clockwise (cw)

## Dimensions

Dimensions in mm

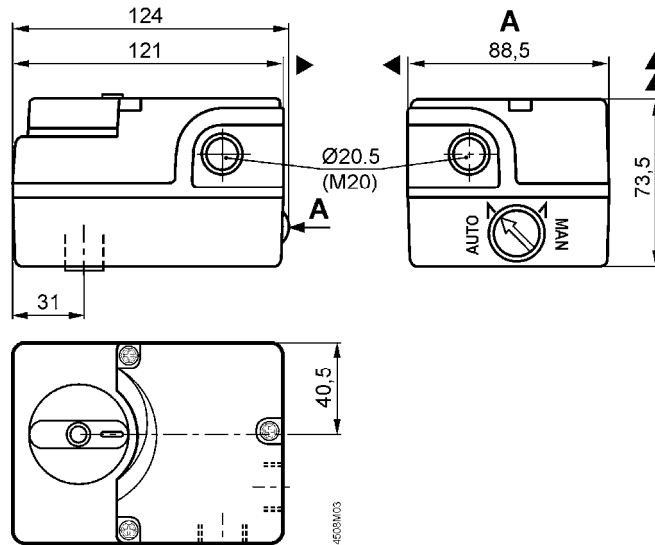

Overall height of valve and actuator

- = Installation height of slipper valve from the middle of the pipe
- + Installation height of the actuator
- + Minimum clearance from ceiling or wall for mounting, connection, operation, service etc.
  - ▶ > 100 mm
  - ▶▶ > 200 mm

## Spare parts

Order number for spare parts

	Cover	Plug	Tappet bush	Scale
<b>Type</b>		 Metric		
<b>SQK34.00</b>	410456408	428056298	417856708	432855288
<b>SQK84.00</b>	410456408	428056298	417856708	432855288

## Revision number

Type	Rev. No, valid from
<b>SQK34.00</b>	..D
<b>SQK84.00</b>	..D

По вопросам продаж и поддержки обращайтесь:

Алматы (7273)495-231  
Ангарск (3955)60-70-56  
Архангельск (8182)63-90-72  
Астрахань (8512)99-46-04  
Барнаул (3852)73-04-60  
Белгород (4722)40-23-64  
Благовещенск (4162)22-76-07  
Брянск (4832)59-03-52  
Владивосток (423)249-28-31  
Владикавказ (8672)28-90-48  
Владимир (4922)49-43-18  
Волгоград (844)278-03-48  
Вологда (8172)26-41-59  
Воронеж (473)204-51-73  
Екатеринбург (343)384-55-89  
Иваново (4932)77-34-06  
Ижевск (3412)26-03-58  
Иркутск (395)279-98-46  
Казань (843)206-01-48

Калининград (4012)72-03-81  
Калуга (4842)92-23-67  
Кемерово (3842)65-04-62  
Киров (8332)68-02-04  
Коломна (4966)23-41-49  
Кострома (4942)77-07-48  
Краснодар (861)203-40-90  
Красноярск (391)204-63-61  
Курган (3522)50-90-47  
Курск (4712)77-13-04  
Липецк (4742)52-20-81  
Магнитогорск (3519)55-03-13  
Москва (495)268-04-70  
Мурманск (8152)59-64-93  
Набережные Челны (8552)20-53-41  
Нижний Новгород (831)429-08-12  
Новокузнецк (3843)20-46-81  
Новосибирск (383)227-86-73  
Ноябрьск(3496)41-32-12

Омск (3812)21-46-40  
Орел (4862)44-53-42  
Оренбург (3532)37-68-04  
Пенза (8412)22-31-16  
Пермь (342)205-81-47  
Петрозаводск (8142)55-98-37  
Псков (8112)59-10-37  
Ростов-на-Дону (863)308-18-15  
Рязань (4912)46-61-64  
Самара (846)206-03-16  
Санкт-Петербург (812)309-46-40  
Саранск (8342)22-96-24  
Саратов (845)249-38-78  
Севастополь (8692)22-31-93  
Симферополь (3652)67-13-56  
Смоленск (4812)29-41-54  
Сочи (862)225-72-31  
Ставрополь (8652)20-65-13  
Сургут (3462)77-98-35

Сыктывкар (8212)25-95-17  
Тамбов (4752)50-40-97  
Тверь (4822)63-31-35  
Тольятти (8482)63-91-07  
Томск (3822)98-41-53  
Тула (4872)33-79-87  
Тюмень (3452)66-21-18  
Улан-Удэ (3012)59-97-51  
Ульяновск (8422)24-23-59  
Уфа (347)229-48-12  
Хабаровск (4212)92-98-04  
Чебоксары (8352)28-53-07  
Челябинск (351)202-03-61  
Череповец (8202)49-02-64  
Чита (3022)38-34-83  
Якутск (4112)23-90-97  
Ярославль (4852)69-52-93

Россия +7(495)268-04-70

Казахстан +7(7172)727-132

Киргизия +996(312)96-26-47

сайт: [www.acvatix.nt-rt.ru](http://www.acvatix.nt-rt.ru) || эл. почта: [atv@nt-rt.ru](mailto:atv@nt-rt.ru)