

По вопросам продаж и поддержки обращайтесь:

Алматы (7273)495-231  
Ангарск (3955)60-70-56  
Архангельск (8182)63-90-72  
Астрахань (8512)99-46-04  
Барнаул (3852)73-04-60  
Белгород (4722)40-23-64  
Благовещенск (4162)22-76-07  
Брянск (4832)59-03-52  
Владивосток (423)249-28-31  
Владикавказ (8672)28-90-48  
Владимир (4922)49-43-18  
Волгоград (844)278-03-48  
Вологда (8172)26-41-59  
Воронеж (473)204-51-73  
Екатеринбург (343)384-55-89  
Иваново (4932)77-34-06  
Ижевск (3412)26-03-58  
Иркутск (395)279-98-46  
Казань (843)206-01-48

Калининград (4012)72-03-81  
Калуга (4842)92-23-67  
Кемерово (3842)65-04-62  
Киров (8332)68-02-04  
Коломна (4966)23-41-49  
Кострома (4942)77-07-48  
Краснодар (861)203-40-90  
Красноярск (391)204-63-61  
Курган (3522)50-90-47  
Курск (4712)77-13-04  
Липецк (4742)52-20-81  
Магнитогорск (3519)55-03-13  
Москва (495)268-04-70  
Мурманск (8152)59-64-93  
Набережные Челны (8552)20-53-41  
Нижний Новгород (831)429-08-12  
Новокузнецк (3843)20-46-81  
Новосибирск (383)227-86-73  
Ноябрьск (3496)41-32-12

Омск (3812)21-46-40  
Орел (4862)44-53-42  
Оренбург (3532)37-68-04  
Пенза (8412)22-31-16  
Пермь (342)205-81-47  
Петрозаводск (8142)55-98-37  
Псков (8112)59-10-37  
Ростов-на-Дону (863)308-18-15  
Рязань (4912)46-61-64  
Самара (846)206-03-16  
Санкт-Петербург (812)309-46-40  
Саранск (8342)22-96-24  
Саратов (845)249-38-78  
Севастополь (8692)22-31-93  
Симферополь (3652)67-13-56  
Смоленск (4812)29-41-54  
Сочи (862)225-72-31  
Ставрополь (8652)20-65-13  
Сургут (3462)77-98-35

Сыктывкар (8212)25-95-17  
Тамбов (4752)50-40-97  
Тверь (4822)63-31-35  
Тольятти (8482)63-91-07  
Томск (3822)98-41-53  
Тула (4872)33-79-87  
Тюмень (3452)66-21-18  
Улан-Удэ (3012)59-97-51  
Ульяновск (8422)24-23-59  
Уфа (347)229-48-12  
Хабаровск (4212)92-98-04  
Чебоксары (8352)28-53-07  
Челябинск (351)202-03-61  
Череповец (8202)49-02-64  
Чита (3022)38-34-83  
Якутск (4112)23-90-97  
Ярославль (4852)69-52-93

Россия +7(495)268-04-70

Казахстан +7(7172)727-132

Киргизия +996(312)96-26-47

сайт: [www.acvatix.nt-rt.ru](http://www.acvatix.nt-rt.ru) || эл. почта: [atv@nt-rt.ru](mailto:atv@nt-rt.ru)



## ТЕХНИЧЕСКИЕ ХАРАКТЕРИСТИКИ НА **SFP21/18** Приводы комбинированных и зональных **SFP71/18** клапанов



- SFP21/18 AC 230 V operating voltage, 2-position control signal
- SFP71/18 AC 24 V operating voltage, 2-position control signal
- 135 N positioning force
- Spring return
- Manual adjustment
- For direct mounting with union nut (no tools required)
- Integral 1.8 m connecting cable
- Auxiliary switch, type ASC2.1/18 (optional)

### Use

The SFP21/18 and SFP71/18 actuators are used in conjunction with zone valves VVP47..., VXP47.. and VMP47..., primarily in heating, ventilation, air conditioning and refrigeration systems for water-based control of low-temperature hot water and cooling water. The SFP.. actuators together with the 3-port valves VXP47.. are suitable for low leakage change over applications.

### Functions

The electric actuator requires an on/off controller (thermostat) to control the valve. If the temperature of the medium deviates from the set-point, the controller output signal causes the actuator to drive the valve open. When the temperature of the medium reaches the set-point, the control signal is cut off and the valve closes again.

## Type summary

Prod. no.	Operating voltage	Positioning time	Control signal	Connecting cable
SFP21/18	AC 230 V	10 s	2-position	1.8 m
SFP71/18	AC 24 V			

## Accessories

Prod. no.	Description	Switching point	Switching capacity	Connecting cable
ASC2.1/18	Auxiliary switch open/closed	At approx. 50% stroke	AC 250 V / 3(2) A	1.8 m

## Ordering

Example:

Product number	Stock number	Designation	Quantity
SFP71/18	SFP71/18	Electromotoric Actuators	2
ASC2.1/18	ASC2.1/18	Auxiliary Switch	1

Delivery

Actuators, valves and accessories are supplied separately. The actuator is supplied with the AL50 ring.

Rev. no.

See overview

## Equipment combinations

Type code	Valve type	$k_{vs}$ [m <sup>3</sup> /h]	PN class	Data sheet
VVP47..	2-port valves	0.25...4.0	PN16	4847
VXP47..	3-port valves	0.25...4.0		
VMP47..	3-port valves with T-bypass	0.25...2.5		

## Technical design / Mechanical design

The valve is opened electrically by the actuator and closed by spring force. It incorporates a synchronous motor, a gear mechanism and a return spring. The electric motor is overload-resistant and anti-locking, so that continuous operation is possible. The maximum stroke is limited mechanically. The closing motion, by contrast, includes an overrun for the gear mechanism. This protects the gear mechanism from mechanical shock and increases service life. The valve is connected by an 1.8 m cable, which is an integral part of the actuator.

## Accessories

### ASC2.1/18 auxiliary switch

The optional auxiliary switch can be fitted to the actuator with two screws.

It switches at a stroke of approx. 50 %.

- Valve actuator de-energized:  
→ Auxiliary switch open
- Voltage applied to valve actuator:  
→ Auxiliary switch closed (50 ... 100 % stroke)
- Manual adjuster locked into position  
(approx. 90 % stroke):  
→ Auxiliary switch closed

See "Technical data" for further information on the auxiliary switch, page 5.

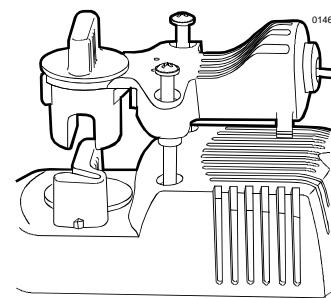

## Notes

### Engineering

The admissible temperatures (see "Technical data", page 5) must be observed.

### Electrical connection

- The actuator may be operated only with alternating current (AC 230 V for SFP21/18 and AC 24V for SFP71/18)

#### ⚠ Caution

- **Phase cut and pulse-width-modulated signals are not suitable.**
- Recommended number of opening/closing operations: approx. 50 per day, with 200 heating or cooling days

### Mounting

Mounting instructions are enclosed with the packaging. Mount ring AL50 prior to mounting the actuator onto V..P47.. valves.

### Orientation

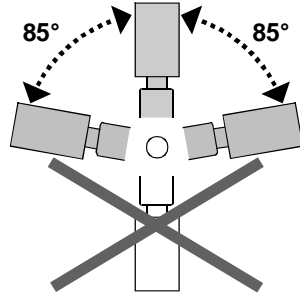

### Commissioning

- Check the wiring.
- Check the functioning of the actuator and of the auxiliary switch, if fitted.

### Operating

The valve can be opened manually by use of a lever on the actuator. When the valve is approximately 90% open this locks into position. When electrical operation is resumed, the locking mechanism is released automatically.

### Manual adjustment

Opening the valve manually

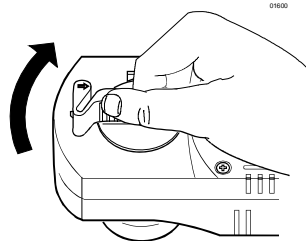

Locking the lever into position at a valve opening of approx. 90%

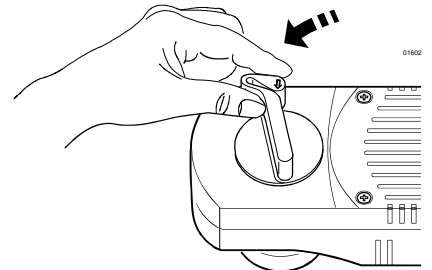

Releasing the lever manually

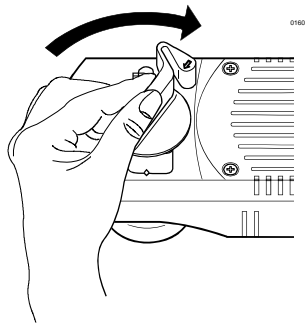

Rotate lever as far as the mechanical stop, and release.

## Maintenance

---

- The actuators require no maintenance.
- In the event of a fault, the actuator can be replaced without removing the valve. The operating voltage must be switched off during this process.
- The actuators cannot be repaired.

## Disposal

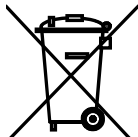

The device contains electrical and electronic components and must not be disposed of together with domestic waste. This applies in particular to the PCB.

Legislation may demand special handling of certain components, or it may be sensible from an ecological point of view.

**Current local legislation must be observed.**

## Warranty

---

The technical data given for these applications is valid only when the valves are used with the actuators described under "Equipment combinations", page 2.

**The use of type SFP.. actuators with third-party valves invalidates any warranty offered by Siemens Building Technologies / HVAC Products.**

## Technical data

		SFP21/18	SFP71/18	
Power supply	Operating voltage	AC 230 V	AC 24 V	
	Voltage tolerance	± 15%	± 20%	
	Frequency	50 Hz		
	Max. power consumption	9.8 VA		
	Fuse protection for incoming cable	Max. 3 A (external)		
Control	Control signal	On/off via temperature controller <i>Phase cut and pulse-width-modulated signals are not suitable.</i>		
	Opening/closing operations	Recommended number: approx. 10 000 / year (equivalent to approx. 50 per day)		
Operating data	Position with de-energized actuator 2-port valve (VVP47..) 3-port valve (VXP47.. and VMP47..)	A → AB closed A → AB closed, B → AB open		
	Positioning time	Opened by motor: 10 s Closed by spring: 30...50 s		
	Nominal stroke	2.5 mm		
	Positioning force	135 N		
	Manual adjustment	0...90 %		
	Admissible temperature of medium in the connected valve:	1...110 °C		
	Electrical connection	Connecting cable (integral)	2-core, 1.8 mm 18 AWG (0.96 mm <sup>2</sup> )	
	Norms and Standards	CE-conformity to EMC directive	2004/108/EC	
Immunity		EN 61000-6-2	Industrial <sup>3)</sup>	
Emissions		EN 61000-6-3	Residential	
Low Voltage Directive		2006/95/EC		
Electrical safety		EN 60730-1		
Protection class to EN 60730, Section 2.7		Class II	Class III	
Pollution degree		to EN 60730, 2		
Housing protection Upright to horizontal	IP30 to EN 60529			
Environmental compatibility	ISO 14001 (Environment) ISO 9001 (Quality) SN 36350 (Environmentally compatible products) RL 2002/95/EG (RoHS)			
Dimensions / Weight	Dimensions	See "Dimensions", page 6		
	Weight			
	without auxiliary switch	0.585 kg	0.585 kg	
with auxiliary switch	0.692 kg	0.692 kg		
Materials	Base-plate Housing	Die-cast aluminum Polycarbonate		
Housing colors	Base and cover	Light gray, RAL7035		
Auxiliary switch (optional)	Switch type	Changeover contact		
	Switching point	at approx. 50 % stroke		
	Switching capacity	AC 250 V 3 A resistive 2 A inductive		
	Connecting cable	3-core, 1.8 mm 18 AWG (0.96 mm <sup>2</sup> )		

## General ambient conditions

	Operation EN 60721-3-3	Transport EN 60721-3-2	Storage EN 60721-3-2
Environmental conditions	Class 3K3	Class 2K3	Class 2K3
Temperature	+1 ... +50 °C	-25 ... +70 °C	-5 ... +50 °C
Humidity	5 ... 85 %rh	< 95 %rh	5 ... 95 %rh

## Connecting cable

Cable	SFP21/18 AC 230 V		SFP71/18 AC 24 V	
	Cable color	Connection	Cable color	Connection
<b>Operating voltage</b> 2-core	Brown	L	Red	G
	Blue	N	Black	G0
<b>Auxil. switch ASC2.1/18</b> <b>(optional)</b> 3-core	Black / Red	Input	Black / Red	Input
	Black / Blue	N/C contact	Black / Blue	N/C contact
	Black / Pink	N/O contact	Black / Pink	N/O contact

## Dimensions

All dimensions in mm

### Actuators without auxiliary switch SFP21/18, SFP71/18

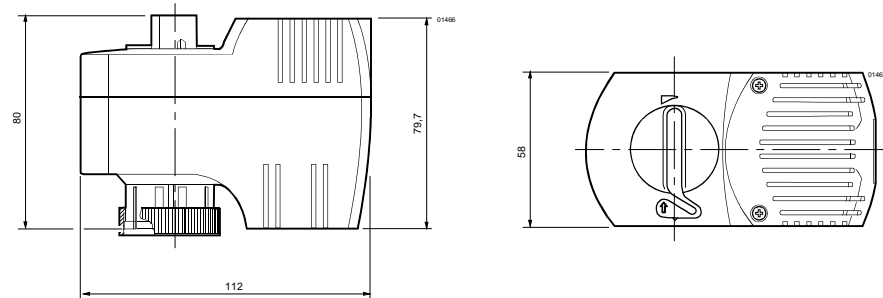

### Actuators with auxiliary switches SFP21/18, SFP71/18 with ASC2.1/18

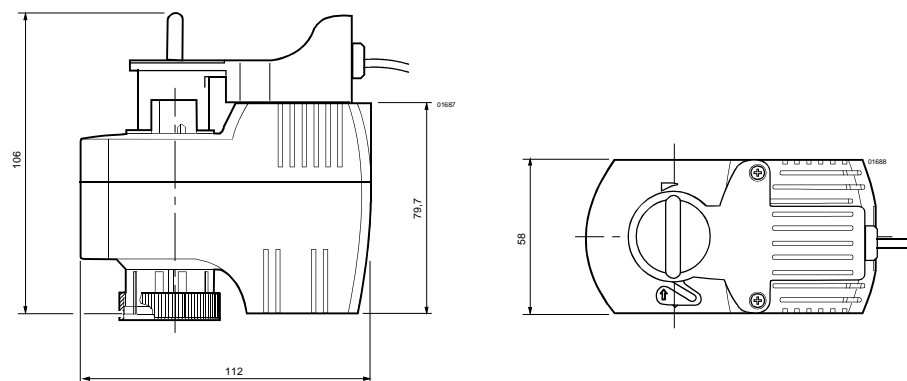

## Revision numbers

Product number	Valid from rev. no.	Product number	Valid from rev. no.
SFP21/18	H	SFP71/18	H

По вопросам продаж и поддержки обращайтесь:

**Алматы** (7273)495-231  
**Ангарск** (3955)60-70-56  
**Архангельск** (8182)63-90-72  
**Астрахань** (8512)99-46-04  
**Барнаул** (3852)73-04-60  
**Белгород** (4722)40-23-64  
**Благовещенск** (4162)22-76-07  
**Брянск** (4832)59-03-52  
**Владивосток** (423)249-28-31  
**Владикавказ** (8672)28-90-48  
**Владимир** (4922)49-43-18  
**Волгоград** (844)278-03-48  
**Вологда** (8172)26-41-59  
**Воронеж** (473)204-51-73  
**Екатеринбург** (343)384-55-89  
**Иваново** (4932)77-34-06  
**Ижевск** (3412)26-03-58  
**Иркутск** (395)279-98-46  
**Казань** (843)206-01-48

**Калининград** (4012)72-03-81  
**Калуга** (4842)92-23-67  
**Кемерово** (3842)65-04-62  
**Киров** (8332)68-02-04  
**Коломна** (4966)23-41-49  
**Кострома** (4942)77-07-48  
**Краснодар** (861)203-40-90  
**Красноярск** (391)204-63-61  
**Курган** (3522)50-90-47  
**Курск** (4712)77-13-04  
**Липецк** (4742)52-20-81  
**Магнитогорск** (3519)55-03-13  
**Москва** (495)268-04-70  
**Мурманск** (8152)59-64-93  
**Набережные Челны** (8552)20-53-41  
**Нижний Новгород** (831)429-08-12  
**Новокузнецк** (3843)20-46-81  
**Новосибирск** (383)227-86-73  
**Ноябрьск**(3496)41-32-12

**Омск** (3812)21-46-40  
**Орел** (4862)44-53-42  
**Оренбург** (3532)37-68-04  
**Пенза** (8412)22-31-16  
**Пермь** (342)205-81-47  
**Петрозаводск** (8142)55-98-37  
**Псков** (8112)59-10-37  
**Ростов-на-Дону** (863)308-18-15  
**Рязань** (4912)46-61-64  
**Самара** (846)206-03-16  
**Санкт-Петербург** (812)309-46-40  
**Саранск** (8342)22-96-24  
**Саратов** (845)249-38-78  
**Севастополь** (8692)22-31-93  
**Симферополь** (3652)67-13-56  
**Смоленск** (4812)29-41-54  
**Сочи** (862)225-72-31  
**Ставрополь** (8652)20-65-13  
**Сургут** (3462)77-98-35

**Сыктывкар** (8212)25-95-17  
**Тамбов** (4752)50-40-97  
**Тверь** (4822)63-31-35  
**Тольятти** (8482)63-91-07  
**Томск** (3822)98-41-53  
**Тула** (4872)33-79-87  
**Тюмень** (3452)66-21-18  
**Улан-Удэ** (3012)59-97-51  
**Ульяновск** (8422)24-23-59  
**Уфа** (347)229-48-12  
**Хабаровск** (4212)92-98-04  
**Чебоксары** (8352)28-53-07  
**Челябинск** (351)202-03-61  
**Череповец** (8202)49-02-64  
**Чита** (3022)38-34-83  
**Якутск** (4112)23-90-97  
**Ярославль** (4852)69-52-93

**Россия** +7(495)268-04-70

**Казахстан** +7(7172)727-132

**Киргизия** +996(312)96-26-47

**сайт: [www.acvatix.nt-rt.ru](http://www.acvatix.nt-rt.ru) || эл. почта: [atv@nt-rt.ru](mailto:atv@nt-rt.ru)**